





MICROMASTER 430

Getting Started Guide



English	<p>Warnings, Cautions and Notes The following Warnings, Cautions and Notes are provided for your safety and as a means of preventing damage to the product or components in the machines connected. Specific Warnings, Cautions and Notes that apply to particular activities are listed at the beginning of the relevant sections. Please read the information carefully, since it is provided for your personal safety and will also help prolong the service life of your inverter and the equipment you connect to it.</p>
Deutsch	<p>Warnungen, Vorsichtshinweise und Hinweise Die nachstehenden Warnungen, Vorsichtshinweise und Hinweise sind für die Sicherheit des Benutzers vorgesehen sowie als Hilfsmittel, um Schaden an dem Erzeugnis oder an Teilen der angeschlossenen Maschine zu verhindern. Spezifische Warnungen, Vorsichtshinweise und Hinweise, die für bestimmte Tätigkeiten gelten, sind am Anfang der jeweiligen Abschnitte zusammengestellt. Bitte diese Informationen sorgfältig lesen, da sie für Ihre persönliche Sicherheit bestimmt sind und auch eine längere Lebensdauer des Umrichters und der daran angeschlossenen Geräte unterstützen.</p>
Français	<p>Avertissements et remarques Les avertissements et remarques figurant dans la suite sont donnés pour assurer la sécurité de l'utilisateur ainsi que pour prévenir des dommages sur le produit ou sur des éléments de la machine raccordée. Les avertissements et remarques spécifiques, applicables à certaines activités, sont regroupés au début du chapitre correspondant. Prière de lire attentivement ces informations car elles sont importantes pour votre sécurité personnelle ainsi que pour assurer une longue durée de vie du variateur ainsi que des appareils raccordés.</p>
Español	<p>Advertencias, precauciones y notas Las presentes advertencias, precauciones y notas están pensadas para su seguridad y como medio para prevenir daños en el producto o en componentes situados en las máquinas conectadas. Advertencias, precauciones y notas específicas aplicables en actividades particulares figuran al comienzo de los capítulos o apartados correspondientes. Rogamos leer cuidadosamente la información ya que se entrega para su seguridad personal y le ayudará a prolongar la vida útil de su convertidor y el equipo que conecte al mismo.</p>
Italiano	<p>Avvertenze tecniche di sicurezza La presente guida operativa contiene avvertenze tecniche relative alla sicurezza delle persone ed alla prevenzione dei danni materiali che vanno assolutamente osservate. Le avvertenze, contrassegnate da un triangolo, a seconda del grado di pericolo, sono chiamate Pericolo, Attenzione, Avvertenze e sono di solito riportate all'inizio dei vari capitoli. Si raccomanda di leggere con attenzione le informazioni fornite, in quanto sono state stilate per garantire l'incolumità personale e per contribuire a prolungare la durata di funzionamento sia dell'Inverter sia delle apparecchiature ad esso collegate.</p>

English	Deutsch	Français
<p> Warnings</p> <ul style="list-style-type: none"> ➤ This equipment contains dangerous voltages and controls potentially dangerous rotating mechanical parts. Non-compliance with Warnings or failure to follow the instructions contained in this manual can result in loss of life, severe personal injury or serious damage to property. ➤ Only suitably qualified personnel should work on this equipment, and only after becoming familiar with all safety notices, installation, operation and maintenance procedures contained in this manual. The successful and safe operation of this equipment is dependent upon its proper handling, installation, operation and maintenance. ➤ The DC link of all MICROMASTER modules remains at a hazardous voltage level for 5 minutes after all voltages have been disconnected. Therefore always wait for 5 minutes after disconnecting the inverter from the power supply before carrying out work on any MICROMASTER modules. ➤ This equipment is capable of providing internal motor overload protection in accordance with UL508C section 42. Refer to P0610 (level 3) and P0335. Motor overload protection can also be provided using an external PTC via a digital input. ➤ This equipment is suitable for use in a circuit capable of delivering not more than 10,000 symmetrical amperes (rms), for a maximum voltage of 460 V when protected by a H or K type fuse. ➤ Class 1 60/75 °C copper wire only. ➤ Refer to the Operating Instructions for tightening torques. ➤ The mains input, DC and motor terminals carry dangerous voltages even if the inverter is inoperative, wait 5 minutes to allow the unit to discharge after switching off before carrying out any installation work. <p>Note Before carrying out any installation and commissioning procedures, you must read all safety instructions and warnings, including all warning labels attached to the equipment. Make sure that the warning labels are kept in a legible condition and ensure missing or damaged labels are replaced.</p>	<p> Warnungen</p> <ul style="list-style-type: none"> ➤ Das vorliegende Gerät führt gefährliche Spannungen und steuert umlaufende mechanische Teile, die gegebenenfalls gefährlich sind. Die Missachtung der Warnungen oder das Nichtbefolgen der in dieser Anleitung enthaltenen Anweisungen kann Lebensgefahr, schwere Körperverletzung oder schwerwiegenden Sachschaden bewirken. ➤ An diesen Geräten darf nur geeignetes, qualifiziertes Personal arbeiten, und nur, nachdem es sich mit allen Sicherheitshinweisen, Installations-, Betriebs- und Wartungsanweisungen, die in dieser Anleitung vorhanden sind, vertraut gemacht hat. Der erfolgreiche und gefahrlose Betrieb des Gerätes hängt von seiner ordnungsgemäßen Handhabung, Installation, Bedienung und Wartung ab. ➤ Der Zwischenkreis aller MICROMASTER-Geräte behält nach dem Abtrennen sämtlicher Spannungen 5 Minuten lang eine gefährliche Spannung bei. Deshalb vor dem Durchführen von Arbeiten an einer der MICROMASTER-Baugruppen nach dem Abtrennen des Umrichters von der Stromversorgung 5 Minuten abwarten. ➤ Dieses Gerät kann inneren Motorüberlastungsschutz gemäß UL508C, Abschnitt 42, herstellen. Siehe P0610 (Stufe 3) und P0335. Motorüberlastungsschutz kann auch durch Verwendung eines externen PTC (Kaltleiters) über einen Digitaleingang hergestellt werden. ➤ Das Gerät ist geeignet für den Einsatz in Stromkreisen, die einen symmetrischen Strom von höchstens 10.000 A (eff) bei einer maximalen Spannung von 460 V liefern, wenn es durch eine Sicherung vom Typ H oder K, Klasse 1 60/75 °C, nur Kupferdraht. ➤ Anzugsdrehmomente: Siehe Betriebsanleitung. ➤ Die Netzanschlussklemmen, die Gleichspannungs- und Motorklemmen führen auch bei nicht arbeitendem Umrichter gefährliche Spannungen; vor dem Durchführen von Installationsarbeiten nach dem Abschalten des Gerätes 5 Minuten für das Entladen abwarten. <p>Hinweise Vor der Durchführung von Installations- und Inbetriebnahmearbeiten unbedingt alle Sicherheitsanweisungen und Warnungen bitte sorgfältig lesen, ebenso alle am Gerät angebrachten Warnschilder. Darauf achten, dass Warnschilder in leserlichem Zustand gehalten werden und dafür sorgen, dass fehlende oder beschädigte Schilder gegebenenfalls ausgetauscht werden.</p>	<p> Attention</p> <ul style="list-style-type: none"> ➤ Le présent appareil est le siège de tensions dangereuses et pilote des pièces mécaniques rotatives qui peuvent présenter une source de danger. Le non-respect des avertissements ainsi que des consignes de sécurité figurant dans cette notice peuvent entraîner la mort, des blessures graves ou des dommages matériels importants. ➤ Seules des personnes qualifiées sont habilitées à intervenir sur cet appareil, et cela uniquement après qu'elles se soient familiarisées avec toutes les consignes de sécurité, les instructions d'installation, d'exploitation et de maintenance mentionnées dans cette notice. ➤ Le fonctionnement correct et sûr de cet appareil présuppose une manipulation, une installation, une utilisation et une maintenance conformes aux règles de l'art. Sur tous les MICROMASTER, il subsiste une tension élevée dans le circuit intermédiaire pendant les 5 minutes qui suivent la mise hors tension. Après coupure du variateur, il faudra par conséquent attendre le temps nécessaire avant d'intervenir sur les modules du MICROMASTER. ➤ Cet appareil est capable d'offrir une protection interne de la surcharge thermique du moteur conforme à UL 508C section 42. Se reporter à P0610 (Niveau 3) et P0335. La protection de surcharge thermique du moteur peut également être assurée par une sonde CTP montée sur le moteur. ➤ Cet équipement convient pour un usage dans un circuit capable de délivrer au plus 10 000 ampères symétriques (eff.) pour une tension maximale de 460 V lorsqu'il est protégé par un fusible type H ou K. ➤ Seulement câble de cuivre Classe 1 60/75 °C ➤ Se référer au manuel d'utilisation pour les couples de serrage ➤ Les bornes du réseau, les bornes de tension continue et de départ vers le moteur peuvent être sous tension dangereuse même lorsque le variateur est à l'arrêt; après coupure du variateur, attendre 5 minutes (décharge des condensateurs) avant d'intervenir sur l'appareil. <p>Remarques Avant de procéder à l'installation et à la mise en service, il faut lire attentivement les consignes de sécurité et les avertissements ainsi que toutes les marques d'avertissement apposées sur l'appareil. Veillez à maintenir la lisibilité des marques d'avertissement et à remplacer celles qui manquent ou qui ont été dégradées.</p>

Español	Italiano
<p> Advertencias</p> <ul style="list-style-type: none"> ➤ Este equipo incluye piezas bajo tensión peligrosa y controla órganos mecánicos en rotación potencialmente peligrosos. El no respeto de las Advertencias o la no observación de las instrucciones contenidas en esta Guía pueden provocar la muerte, lesiones graves o daños materiales considerables. ➤ En este equipo sólo deberá trabajar personal adecuadamente cualificado y sólo una vez familiarizado con todas las consignas de seguridad, procedimientos de instalación, operación y mantenimiento contenidos en este Manual. El funcionamiento exitoso y seguro de este equipo depende de si ha sido manipulado, instalado, operado y mantenido adecuadamente. ➤ En el circuito intermedio de todos los módulos MICROMASTER permanece un nivel de tensión peligroso durante 5 minutos tras que hayan sido desconectadas todas las tensiones. Por ello, una vez desconectado el convertidor de la fuente de alimentación, esperar 5 minutos antes de efectuar trabajos en cualquier módulo MICROMASTER. ➤ Este equipo suministra internamente la protección contra sobrecarga del motor de acuerdo a la UL508C sección 42. Referirse al P0610 (nivel 3) y P0335. Puede conseguirse también protección contra sobrecargas del motor utilizando una PTC externa a través de una entrada digital. ➤ Este equipo es apto para utilizarlo en un circuito capaz de entregar como máximo 10.000 amperios simétricos (eficaces), para una tensión máxima de 460 V si está protegido por fusible de tipo H o K. ➤ Sólo cableado de cobre Clase 1 60/75 °C. ➤ Referirse al Manual de Instrucciones para los pares de apriete. ➤ Las entradas de red, los bornes de corriente continua y del motor pueden estar sometidas a tensión peligrosa aunque no esté funcionando el convertidor; antes de realizar cualquier trabajo de instalación, esperar 5 minutos para que la unidad pueda descargarse después de haberse desconectada de la fuente de alimentación. <p>Notes Antes de efectuar cualquier tipo de trabajo de instalación y puesta en servicio es necesario leer todas las instrucciones y advertencias de seguridad, incluyendo los rótulos de advertencia fijados al equipo. Asegurarse de que dichos rótulos y advertencias sean siempre legibles y tomar las medidas necesarias para sustituir inmediatamente los rótulos perdidos o dañados.</p>	<p> Pericolo</p> <ul style="list-style-type: none"> ➤ La presente apparecchiatura contiene tensioni pericolose e controlla parti meccaniche rotanti potenzialmente pericolose. L'inservanza delle relative misure di sicurezza può causare la morte, gravi lesioni alle persone e ingenti danni materiali. ➤ Sulla presente apparecchiatura dovrà operare esclusivamente personale appositamente qualificato e solamente dopo che abbia acquisito piena dimestichezza in merito a tutte le informazioni di sicurezza ed alle procedure di installazione, uso e manutenzione riportate in questa guida. Il corretto e sicuro funzionamento della presente apparecchiatura dipende dall'idoneità degli interventi di installazione, uso e manutenzione. ➤ Il circuito intermedio di tutti i moduli MICROMASTER rimane caricato a livelli pericolosi di tensione per 5 minuti dopo aver disattivato tutte le alimentazioni elettriche. Di conseguenza, prima di effettuare qualsiasi intervento sui moduli MICROMASTER, si raccomanda di attendere almeno 5 minuti dopo aver disattivato l'inverter. ➤ Questo apparecchio è in grado di provvedere internamente alla protezione per sovraccarico del motore in accordo con UL508C parte 42. Riferimento a P0610 (livello 3) e P0335. La protezione per sovraccarico del motore può essere realizzata anche usando una PTC esterna tramite ingresso digitale. ➤ La presente apparecchiatura è indicata per l'uso in un circuito in grado di erogare sino a 10.000 ampere simmetrici (rms), per una tensione massima di 460 V quando protetto da un fusibile di tipo H o di tipo K. ➤ Classe 1 60/75 °C solo filo di rame. ➤ Riferimento alle Istruzioni di servizio per coppie di serraggio. ➤ I morsetti di allacciamento alla rete, quelli in c.c. e quelli sul motore possono trovarsi a tensioni pericolose anche nel caso in cui l'inverter sia disattivato, prima di effettuare interventi di installazione attendere 5 minuti dopo averlo disattivato. <p>Avvertenza Prima di procedere all'installazione ed alla messa in esercizio, è necessario leggere attentamente le istruzioni di sicurezza e le avvertenze, incluse tutte le targhette di avvertimento applicate alle apparecchiature. Accertarsi che le targhette di avvertimento siano conservate in condizioni leggibili e si abbia cura di sostituire le targhette mancanti o danneggiate.</p>

Dimension Drawings

Maßbilder

Encombrements

Dibujos acotados

Disegni quotati

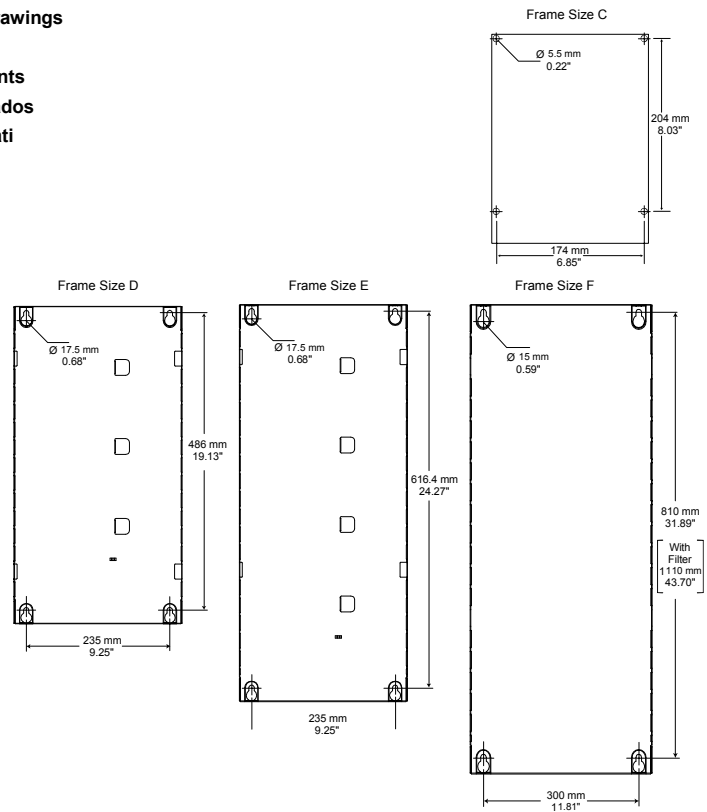

Frame Size FX

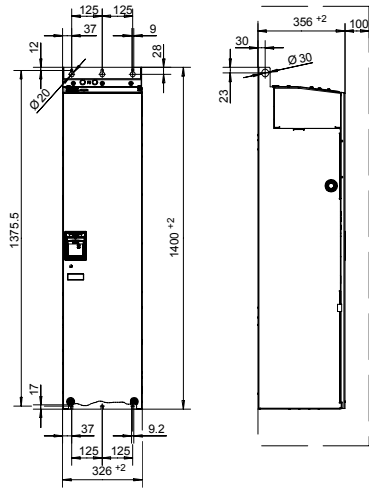

Frame Size GX

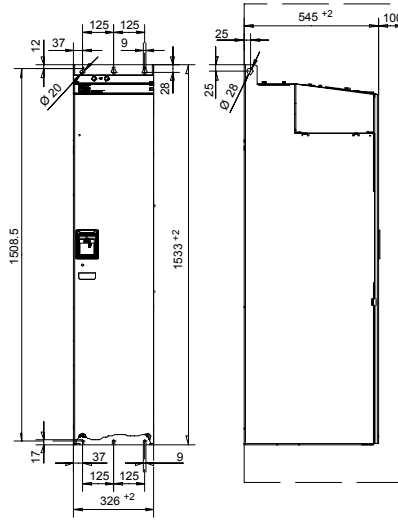

Connecting Power Terminals

Leistungsanschlüsse

Connexions de puissance

Conectores de carga

Conessioni

Inverter
Umrichter
Variateur
Convertidor
Inverter

Frame Size C

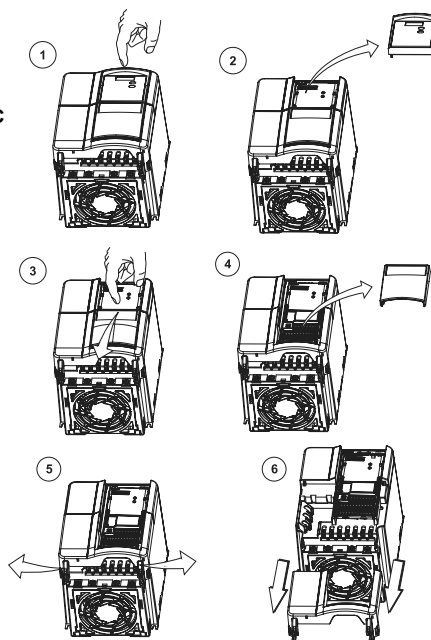
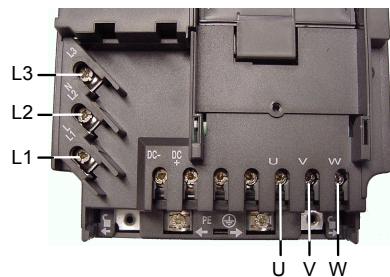

6

MICROMASTER 430, Getting Started Guide 12/02

Frame Size D & E

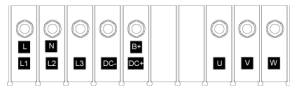
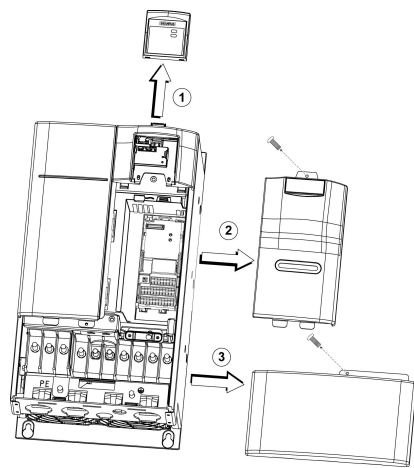

Frame Size F

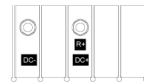
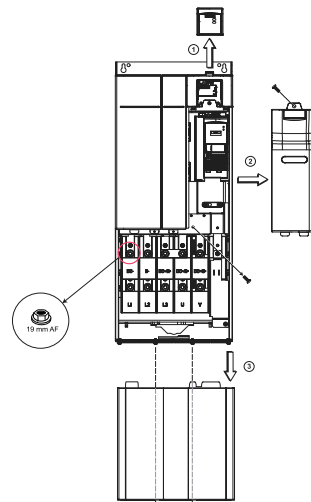

Frame Size FX/GX

Inverter
Umrichter
Variateur
Convertidor
Inverter

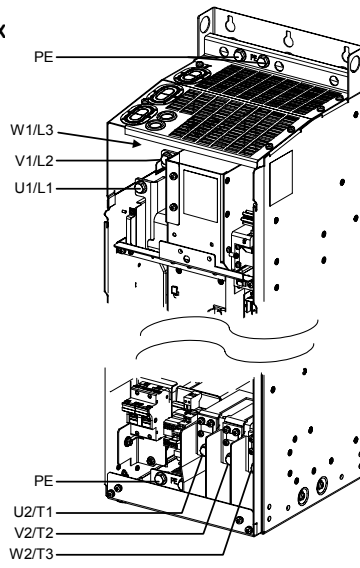

Motor
Motor
Moteur
Motor
Motore

PE = Ground

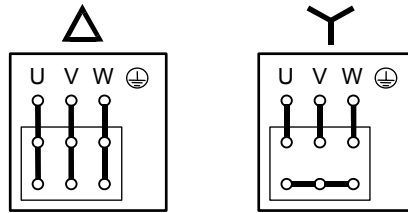

Connecting Control Terminals
Anschließen der Steuerklemmen
Connexions de commande
Conectores para líneas de control
Connessione dei morsetti di comando

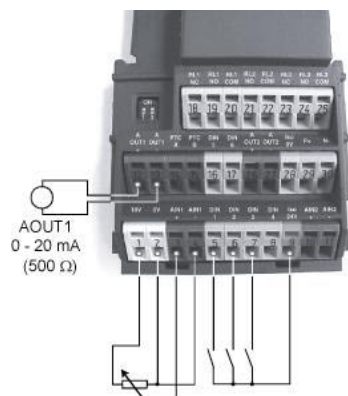

Motor Frequency Remove SDP and I/O board

Motorfrequenz
Fréquence moteur
Frecuencia del motor
Frequenza motore

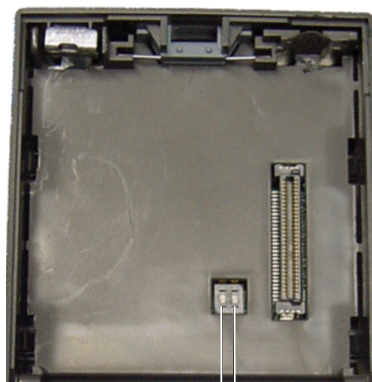
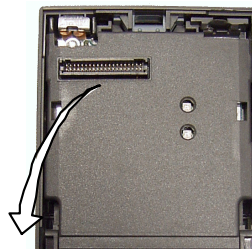

Dip Switch 1
 Not for customer use
 Keine Kundenfunktion
 Sans fonction pour le client
 No para uso del cliente
 Non deve essere utilizzato

Dip Switch 2
 OFF f = 50Hz; ON f = 60Hz
 Default Setting = OFF
 Werkseinstellung = OFF
 Réglage usine = OFF
 Ajuste de fábrica = OFF
 Default = OFF

English	<p>Commissioning</p> <p>The MICROMASTER 430 comes with a Status Display Panel (SDP) and default parameters settings to cover the following:</p> <ul style="list-style-type: none"> ➤ Motor rating data; voltage, current and frequency are all compatible with the inverter data ➤ Linear V/f motor speed, controlled by an analog potentiometer ➤ Maximum speed 3000 rpm with 50 Hz (3600 rpm with 60 Hz); controllable using a potentiometer via the inverter's analogue inputs ➤ Ramp-up time / Ramp-down time = 10 s
Deutsch	<p>Inbetriebnahme</p> <p>Der MICROMASTER 430 wird mit einem Zustands-Anzeigefeld (Status Display Panel, SDP) und mit Parameter-einstellungen geliefert, die folgende Anforderungen abdecken:</p> <ul style="list-style-type: none"> ➤ Die Motordaten, Spannung, Strom und Frequenz sind sämtlich mit den Daten des Umrichters kompatibel ➤ Lineare U/f-Kennlinie für Motordrehzahl, durch ein analoges Potentiometer gesteuert ➤ Höchstdrehzahl 3000/min bei 50 Hz (3600/min bei 60 Hz); steuerbar über ein an die Analogeingänge des Umrichters angeschlossenes Potentiometer ➤ Rampenhochlaufzeit / Rampenrücklaufzeit = 10 s
Français	<p>Mise en service</p> <p>Le MICROMASTER 430 est fourni avec un panneau d'affichage SDP et avec un pré réglage des paramètres couvrant les exigences suivantes :</p> <ul style="list-style-type: none"> ➤ Les caractéristiques nominales du moteur, la tension, le courant et la fréquence sont compatibles avec les caractéristiques du variateur ➤ Caractéristique linéaire de vitesse U/f avec commande par potentiomètre ➤ Vitesse maximale 3000 tr/min à 50 Hz (3600 tr/min à 60 Hz) ; réglable par un potentiomètre raccordé à une entrée analogique du variateur ➤ Temps de montée et temps de descente de 10 s
Español	<p>Puesta en servicio</p> <p>El MICROMASTER 430 se entrega equipado con un panel SDP (Status Display Panel) y parámetros ajustados por defecto que cubren los requisitos siguientes:</p> <ul style="list-style-type: none"> ➤ Los datos nominales del motor – tensión, corriente y frecuencia – son todos compatibles con los datos del convertidor ➤ Característica V/f lineal de variación de velocidad en el motor, controlada por un potenciómetro analógico ➤ Velocidad máxima 3000/min con 50 Hz (3600/min con 60 Hz), controlable con un potenciómetro a través de las entradas analógicas del convertidor ➤ Tiempo de aceleración / tiempo de deceleración = 10 s
Italiano	<p>Messa in servizio</p> <p>L MICROMASTER 430 è fornito con un display (Status Display Panel) per la visualizzazione e l'impostazione di parametri di default con il quale si può verificare:</p> <ul style="list-style-type: none"> ➤ Compatibilità dei dati di targa del motore, della tensione, della corrente e della frequenza ai dati dell'inverter ➤ Velocità lineare V/f del motore controllata da un potenziometro analogico ➤ Velocità massima di 3000/min a 50 Hz (3600/min a 60 Hz); controllabile tramite potenziometro attraverso gli ingressi analogici dell'inverter ➤ Tempo di accelerazione / Tempo di decelerazione = 10 s

English	For details and more complex applications please refer to the "Operating Instructions" and the "Parameter List", both part of the CD ROM, delivered with your inverter. This "Getting Started Guide" contains a Quick Commissioning description with the BOP-2. The description of the BOP-2 you will find in the "Operating Instructions".
Deutsch	Für weitere Informationen und komplexere Anwendungen stehen Ihnen die Betriebsanleitung und die detaillierte Parameterbeschreibung zur Verfügung, beide sind Bestandteil der mit dem Umrichter gelieferten CD-ROM. Diese Kurzanleitung enthält eine Beschreibung zur Schnellinbetriebnahme mit dem BOP-2. Eine Erläuterung der BOP-2-Tastatur finden Sie in der Betriebsanleitung.
Français	Pour de plus amples informations et des applications plus complexes, veuillez vous référer aux instructions de service et à la description détaillée des paramètres qui se trouvent toutes deux sur le CD-ROM fourni avec le variateur. Le présent guide contient une description pour la mise en service rapide au moyen du BOP-2. Le clavier du BOP-2 est expliqué dans les instructions de service.
Español	Si se requieren más detalles para aplicaciones más complejas, consultar las "Instrucciones de uso" y la "Lista de parámetros" que se encuentran en el CD-ROM suministrado con el convertidor. Estas instrucciones de uso contienen una descripción de la puesta en servicio con el panel BOP-2. Encontrará la descripción del BOP-2 en las Instrucciones de uso.
Italiano	Per maggiori informazioni relative ad applicazioni più complesse, si veda la lista parametri delle Istruzioni di servizio. La guida sintetica contiene una descrizione della messa in servizio rapida mediante BOP-2. Le spiegazioni relative alla tastiera BOP-2 sono riportate nelle istruzioni di servizio.

	English	Deutsch
P0010 1 = Quick Commissioning	Start Quick Commissioning P0010 must always be set back to '0' before operating the motor. However if P3900 = 1 is set after commissioning this is done automatically	Start Schnellinbetriebnahme P0010 muss vor der Inbetriebnahme des Motors auf '0' zurückgesetzt werden. Wird nach der Inbetriebnahme P3900 = 1 eingestellt, dann erfolgt dies automatisch.
P0100 0 = kW / 50 Hz 1 = hp / 60 Hz 2 = kW / 60 Hz	Operation for Europe / N. America For setting 0 and 1 use DIP Switch 2. For setting 2 use P0100	Betrieb für Europa / Nordamerika Die Einstellungen 0 und 1 sind über DIP-Schalter 2 herzustellen. Einstellung 2 über P0100
P0304 10 V - 2000 V	Rated Motor Voltage Nominal motor voltage (V) from rating plate	Motornennspannung Motornennspannung (V) vom Typenschild des Motors
P0305 0 ... 2 * I _{nom}	Rated Motor Current Nominal motor current (A) from rating plate	Motornennstrom I _{nom} = Motornennstrom (A) vom Typenschild
P0307 0 kW - 2000 kW	Rated Motor Power Nominal motor power (kW) from rating plate. If P0100 = 1, values will be in hp	Motornennleistung Motornennleistung (kW) vom Typenschild. Bei P0100 = 1, sind die Werte in hp
P0310 12 Hz - 650 Hz	Rated Motor Frequency Nominal motor frequency (Hz) from rating plate	Motornennfrequenz Motornennfrequenz (Hz) vom Typenschild















Français	Español	Italiano
<p>Mise en service rapide A noter qu'avant la mise en service du moteur, P0010 doit toujours être réglé sur '0'. Ceci s'effectue automatiquement si P3900 = 1 après la mise en service</p>	<p>Puesta en servicio rápida Recuerde que P0010 debe retomarse siempre a '0' antes de poner en marcha el motor. Sin embargo, si tras la puesta en servicio se ajusta P3900 = 1, esto se hace automáticamente</p>	<p>Avvio messa in servizio rapida Si tenga presente che il parametro P0010 deve sempre essere riportato a '0' prima di azionare il motore. Tuttavia, se dopo la messa in servizio il parametro P3900 viene impostato a 1, questa operazione verrà eseguita automaticamente.</p>
<p>Exploitation en Europe / Amérique du Nord Pour les réglages 0 et 1, utiliser l'interrupteur DIP 2 Le réglage 2 s'établit par le par. P0100.</p>	<p>Europa / Norteamérica Para los ajustes 0 y 1, use interruptor DIP 2 Para el ajuste 2, use P0100</p>	<p>Funzionamento per Europa / N. America Impostare 0 e 1 mediante DIP Switch 2. Impostare 2 mediante P0100</p>
<p>Tension nom. du moteur Tension nominale du moteur (V) relevée sur la plaque signalétique</p>	<p>Tensión nom. del motor Tensión nominal del motor (V) tomada de la placa de características</p>	<p>Tensione nominale motore Tensione nominale del motore (V) ricavata dai dati di targa caratteristici.</p>
<p>Courant nom. du moteur Courant nominal du moteur (A) relevé sur la plaque signalétique</p>	<p>Corriente nom. del motor Corriente nominal del motor (A) tomada de la placa de características</p>	<p>Corrente nominale motore Corrente nominale del motore (A) ricavata dai dati di targa caratteristici.</p>
<p>Puissance nom. moteur Puissance nom. du moteur (kW) relevée sur la plaque signalétique. Pour P0100 = 1, valeurs en hp</p>	<p>Potencia nom. del motor Potencia nominal del motor (kW) tomada de la placa de características. Si P0100 = 1, los valores deberán ser en hp</p>	<p>Potenza nominale motore Potenza nominale del motore (kW) ricavata dai dati di targa caratteristici. Se il parametro P0100 = 1, i valori saranno in hp.</p>
<p>Fréquence nom. moteur Fréquence nominale du moteur (Hz) relevée sur la plaque signalétique</p>	<p>Frecuencia nominal del motor Frecuencia nominal del motor (Hz) tomada de la placa de características</p>	<p>Frequenza nominale motore Frequenza nominale del motore (Hz) ricavata dai dati di targa caratteristici.</p>

	English	Deutsch
P0311 0 - 40000 1/min	Rated Motor Speed Nominal motor speed (rpm) from rating plate	Motorenndrehzahl Motorenndrehzahl (1/min) vom Typenschild
P0700	Selection of Command Source (on / off / reverse) 1 = BOP-2 2 = Terminal / Digital Inputs (default)	Wahl von Befehlsquellen (EIN / AUS / Richtungsumkehr) 1 = BOP-2 2 = Klemmen (Werkseinstellung)
P1000	Selection of Frequency Setpoint 1 = BOP-2 2 = Analogue Setpoint (default)	Wahl des Frequenzsollwerts 1 = BOP-2 2 = Analogsollwert (Werkseinstellung)
P1080	Min. Motor Frequency Sets minimum motor frequency (0 - 650 Hz) at which the motor will run irrespective of the frequency setpoint. The value set here is valid for both clockwise and anti-clockwise rotation	Minimal Motorfrequenz Stellt die minimale Motorfrequenz (0 - 650 Hz) ein, mit der der Motor unabhängig vom Frequenzsollwert läuft. Der hier eingestellte Wert gilt für beide Drehrichtungen
P1082	Max. Motor Frequency Sets maximum motor frequency (0 - 650 Hz) at which the motor will run at irrespective of the frequency setpoint. The value set here is valid for both clockwise and anti-clockwise rotation	Maximal Motorfrequenz Stellt die höchste Motorfrequenz (0 - 650 Hz) ein, mit der der Motor unabhängig vom Frequenzsollwert läuft. Der hier eingestellte Wert gilt für beide Drehrichtungen

Français	Español	Italiano
Vitesse nom. du moteur Vitesse nominale du moteur (tr/min) relevée sur la plaque signalétique	Velocidad nominal del motor Velocidad nominal del motor (rpm) tomada de la placa de características	Velocità nominale motore Velocità nominale del motore (giri/minuto) ricavata dai dati di targa del motore.
Sélection de la source de commande (marche/arrêt/inversion de sens) 1 = BOP-2 2 = bornes (réglage usine)	Selección de la fuente de órdenes (on / off / inverso) 1 = BOP-2 2 = Bornes/terminales (Ajuste de fábrica)	Selezione della sorgente di comando (on / off / inversione) 1 = BOP-2 2 = Terminale (Default)
Sélection de la consigne de fréquence 1 = BOP-2 2 = consigne analogique (réglage usine)	Selección de la consigna de frecuencia 1 = BOP-2 2 = Consigna analógica (Ajuste de fábrica)	Selezione del valore di riferimento frequenza 1 = BOP-2 2 = Valore di riferimento analogico (Default)
Fréquence moteur min. Réglage de la fréquence minimale du moteur (0 - 650 Hz) indépendamment de la consigne de fréquence. Cette valeur est valable pour les deux sens de rotation.	Frecuencia mín. del motor Ajuste del mínimo de la frecuencia del motor (0 - 650 Hz) a partir de la cual girará el motor con indiferencia de la consigna de frecuencia ajustada. El valor aquí ajustado es válido tanto para giro horario (a derechas) como antihorario (a izquierdas)	Frequenza min. motore Imposta la frequenza minima (0 - 650 Hz) di funzionamento del motore, indipendentemente dal valore di riferimento frequenza. Il valore qui impostato è valido per il senso di rotazione sia orario sia antiorario.
Fréquence moteur max. Réglage de la fréquence maximale du moteur (0 - 650 Hz) indépendamment de la consigne de fréquence. Cette valeur est valable pour les deux sens de rotation	Frec. máx. del motor Ajuste del máximo de la frec. del motor (0 - 650 Hz) a partir de la cual girará el motor con indiferencia de la consigna de frec. ajustada. El valor aquí ajustado es válido tanto para giro horario como antihorario	Frequenza max. motore Imposta la frequenza massima (0 - 650 Hz) di funzionamento del motore, indipendentemente dal valore di riferimento frequenza. Il valore qui impostato è valido per il senso di rotazione sia orario sia antiorario.

	English	Deutsch
P1120 0 - 650 s	Ramp-Up Time Time taken for the motor to accelerate from standstill up to maximum motor frequency.	Rampenhochlaufzeit Zeit für das Beschleunigen vom Stillstand bis zur maximalen Motorfrequenz.
P1121 0 - 650 s	Ramp-Down Time Time taken for motor to decelerate from maximum motor frequency down to standstill	Rampenrücklaufzeit Zeit zum Verzögern von höchster Motorfrequenz bis zum Stillstand
P3900	End Quick Commissioning 0 = End Quick Commissioning without motor calculation or factory reset. 1 = End Quick Commissioning with motor calculation and factory reset (Recommended). 2 = End Quick Commissioning with motor calculation and with I/O reset. 3= End Quick Commissioning with motor calculation but without I/O reset.	Ende Schnellobetriebnahme 0 = Beendet die Schnellobetriebnahme auf Basis der aktuellen Einstellungen (ohne Motorberechnung). 1 = Beendet die Schnellobetriebnahme auf Basis der Werkeinstellung (mit Motorberechnung) (empfohlen). 2 = Beendet die Schnellobetriebnahme auf der Basis der aktuellen Einstellungen (mit Motorberechnung und E/A-Rücksetzung). 3= Beendet die Schnellobetriebnahme auf der Basis der aktuellen Einstellungen (mit Motorberechnung, ohne E/A-Rücksetzung).

Français	Español	Italiano
Temps de montée Temps de rampe pour accélérer de l'arrêt à la fréquence moteur maximale.	Tiempo de aceleración Tiempo que lleva al motor acelerar de la parada a la frecuencia máxima ajustada	Tempo di accelerazione Tempo richiesto dal motore per accelerare da fermo sino alla frequenza massima.
Temps de descente Temps de rampe nécessaire à la décélération de la fréquence moteur maximale jusqu'à l'arrêt.	Tiempo de deceleración Tiempo que lleva al motor decelerar de la frecuencia máx. del motor a la parada	Tempo di decelerazione Tempo richiesto dal motore per decelerare dalla frequenza massima sino alla condizione di fermo
Fin de la mise en service rapide 0 = Termine la mise en service rapide sur la base des réglages actuels (sans calcul du moteur). 1 = Termine la mise en service rapide sur la base des réglages usine (avec calcul du moteur) (recommandé) . 2 = Termine la mise en service rapide sur la base des réglages actuels (avec calcul du moteur et remise à zéro des E/S). 3 = Termine la mise en service rapide sur la base des réglages actuels (avec calcul du moteur, sans remise à zéro des E/S).	Fin de p. e. s. rápida 0 = Finaliza la puesta en servicio rápida basándose en los ajustes actuales (sin cálculo del motor). 1 = Finaliza la puesta en servicio rápida basándose en los ajustes de fábrica (con cálculo del motor) (recomendado) . 2 = Finaliza la puesta en servicio rápida basándose en los ajustes actuales (con cálculo del motor y reseteo de E/S). 3 = Finaliza la puesta en servicio rápida basándose en los ajustes actuales (con cálculo de motor, sin reseteo de E/S).	Fine messa in servizio rapida 0 = Termina la messa in servizio rapida in base alle impostazioni attuali (senza calcolo motore). 1 = Termina la messa in servizio rapida in base all'impostazione di fabbrica (con calcolo motore) (Raccomandato) . 2 = Termina la messa in servizio rapida in base alle impostazioni attuali (con calcolo motore e ripristino I/O). 3 = Termina la messa in servizio rapida in base alle impostazioni attuali (con calcolo motore, senza ripristino I/O).

 	Mains not present Keine Netzspannung Pas de tension réseau Red no presente Alimentazione di rete non presente
 	Ready to run Betriebsbereit Variateur prêt au service Preparado para funcionar Pronto ad entrare in funzione
 	Inverter fault - other than the ones listed below Andere Umrichterstörung als unten aufgezählt Autre défaut du variateur que ci-dessous Fallo en convertidor, uno de los listados abajo Errore inverter - diverso da quelli sotto elencati
 	Inverter running Umrichter in Betrieb Variateur en fonctionnement Convertidor en marcha Inverter in funzione
 	Fault overcurrent Störung Überstrom Défaut surintensité Fallo sobrecorriente Errore sovracorrente
 	Fault overvoltage Störung Überspannung Défaut surtension Fallo sobretensión Errore sovratensione
 	Fault motor overtemperature Störung Motorübertemperatur Défaut surchauffe moteur Fallo sobrettemperatura motor Errore surriscaldamento motore











LEDs for indicating the drive state
Anzeige des Umrichterzustands
LED d'état du variateur
LEDs indicadores estado de accionamiento
Led di visualizzazione dello stato del convertitore

 On Ein Marche On On
--

 Off Aus Arrêt Off Off
--

 ca. 0,3 s Flashing Flackernd Papillotement Parpadeo Sfarfallante
--

 ca. 1 s Twinkling Blinkend Clignotement Intermittencia Intermittente
--

	Fault inverter temperature Störung Umrichterübertemperatur Défaut surchauffe variateur Fallo sobretemperatura convertidor Errore surriscaldamento inverter
	Warning current limit - both LEDs twinkling same time Warnung Stromgrenzwert - Beide LEDs blinken gleichzeitig Seuil d'alarme de courant - les deux LED clignotent en phase Alarma límite corriente - Ambos LEDs intermiten al mismo tiempo Segnalazione limite corrente - Lampeggio intermittente contemporaneo di entrambi i LED
	Other warnings - both LEDs twinkling alternatively Sonstige Warnungen - Beide LEDs blinken abwechselnd Autres alarmes - les deux LED clignotent en alternance Otras alarmas - Ambos LEDs intermiten alternativamente Altre segnalazioni - Lampeggio intermittente alternato di entrambi i LED
	Undervoltage trip / undervoltage warning Unterspannungsabschaltung/-warnung Coupure/alarme de sous tension Disparo/alarma por minima tension Scatto per sottotensione / segnalazione sottotensione
	Drive is not in ready state - Display state > 0 Umrichter nicht bereit - Anzeige > 0 Variateur non prêt - affichage > 0 Accionamento no listo - Estado display > 0 Azionamento non in stato pronto - Stato display > 0
	ROM failure - Both LEDs flashing same time ROM Störung - Beide LEDs flackern gleichzeitig Défaut ROM - les deux LED papillotent en phase Fallo en ROM - Ambos LEDs parpadean al mismo tiempo Errore ROM - Sfarfallio contemporaneo di entrambi i LED
	RAM failure - Both LEDs flashing alternatively RAM Störung - Beide LEDs flackern abwechselnd Défaut RAM - les deux LED papillotent en alternance Fallo en RAM - Ambos LEDs parpadean alternativamente Errore RAM - Sfarfallio alternato di entrambi i LED

 European Low Voltage Directive
Europäische Niederspannungsrichtlinie
Directive européenne basse tension
Diretiva europea "Baja tension"
Direttiva europea sulla bassa tensione

European Machinery Directive
Europäische Maschinenrichtlinie
Directive Machines européenne
Diretiva europea "Maquinas"
Direttiva europea macchine

European EMC Directive
Europäische EMV-Richtlinie
Directive CEM européenne
Diretiva europea "Compatibilidad electromagnetica"
Direttiva europea EMC



Underwriters Laboratories
UL and CUL LISTED POWER CONVERSION EQUIPMENT
5B33 for use in a pollution degree 2.

ISO 9001
Siemens plc operates a quality management system, which
complies with the requirements of ISO 9001.

<http://www.siemens.de/micromaster>